

EX-MHF-F Handsfree CONTACTLESS Exit Device, flush mounted

Q N° 008/1

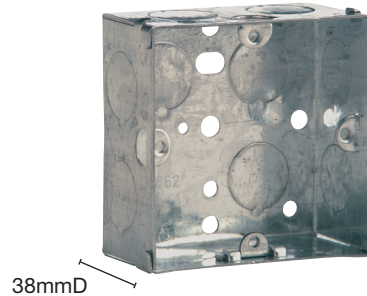

EX-MHF-PL
with back-up H & S double pole
"mushroom" type exit button



1G
Flush internal only



MAX 1 METRE DISTANCE AT MAX 1 METRE HEIGHT AFFL FROM DOOR PULL/PUSH HANDLE.

STANDBY MODE

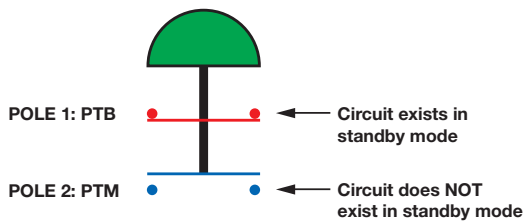

PRESS THE BUTTON

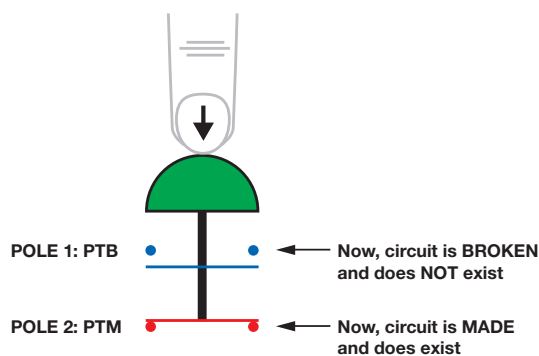

ALWAYS CHECK THAT BOTH POLES HAVE BEEN USED AND THAT WHEN THE BUTTON IS PUSHED AND HELD DOWN THE DOOR STAYS UNLOCKED AND DOES NOT RE-LOCK.

PTB = PUSH TO BREAK

When the button is pressed the lock cable circuit is broken. No power gets to the FAIL SAFE locking device. The locking FAILS in the safe / unlocked mode so people can get out of the building. Whilst the button is held pressed in the door locking remains in the unlocked mode. The PTB part of the button creates a mechanical break in the lock cabling circuit and is for **SAFETY**.

PTM = PUSH TO MAKE

When the button is pressed a signal is sent to the door controller to open the door for a pre-programmed length of time for the comfort of the resident. The PTM part of the button is a **CONVENIENCE** device only.

THIS IS NOT A LIFE SAFETY DEVICE.

Double Pole (DP) Green Mushroom Button with 1no PTM pole for convenience and 1no PTB pole for safety. This is a **NON-LATCHING** meaning Non-Hold-Unlocked exit device. **ONLY USE** with fail safe electric locking. It also has a Hands-Free sensor for convenience egress. Always fit within 1 metre max distance of the relevant door exit pull/push handle, max height 1 metre AFFL.

Engraved: PUSH TO EXIT (Green) for normal egress.

ONLY USE IN CONJUNCTION with a secondary independent emergency door release system. It is your responsibility to check and ensure your installation complies fully with Building Control regulations (www.labc.co.uk) for emergency safe egress.



EX-MHF-S Handsfree CONTACTLESS Exit Device, surface mounted

Q N° 008/2



EX-MHF-PL

with back-up H & S double pole
"mushroom" type exit button



38mmD

1G

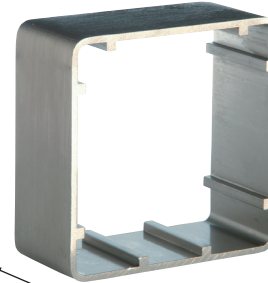

38mmD

EX-PLSB-SB

Surface internal only



MAX 1 METRE DISTANCE AT MAX 1 METRE HEIGHT AFFL FROM DOOR PULL/PUSH HANDLE.

STANDBY MODE

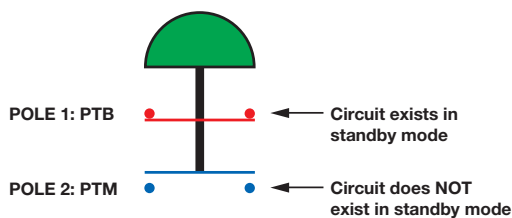

PRESS THE BUTTON

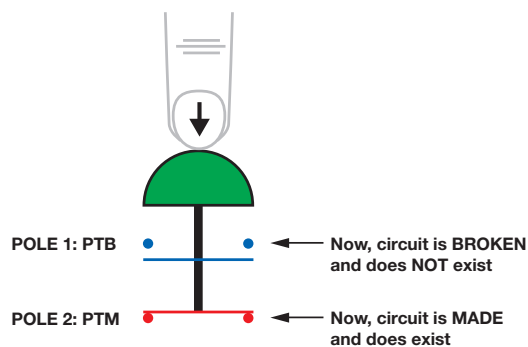

ALWAYS CHECK THAT BOTH POLES HAVE BEEN USED AND THAT WHEN THE BUTTON IS PUSHED AND HELD DOWN THE DOOR STAYS UNLOCKED AND DOES NOT RE-LOCK.

PTB = PUSH TO BREAK

When the button is pressed the lock cable circuit is broken. No power gets to the FAIL SAFE locking device. The locking FAILS in the safe / unlocked mode so people can get out of the building. Whilst the button is held pressed in the door locking remains in the unlocked mode. The PTB part of the button creates a mechanical break in the lock cabling circuit and is for **SAFETY**.

PTM = PUSH TO MAKE

When the button is pressed a signal is sent to the door controller to open the door for a pre-programmed length of time for the comfort of the resident. The PTM part of the button is a **CONVENIENCE** device only.

THIS IS NOT A LIFE SAFETY DEVICE.

Double Pole (DP) Green Mushroom Button with 1no PTM pole for convenience and 1no PTB pole for safety. This is a **NON-LATCHING** meaning Non-Hold-Unlocked exit device. **ONLY USE** with fail safe electric locking. It also has a Hands-Free sensor for convenience egress. Always fit within 1 metre max distance of the relevant door exit pull/push handle, max height 1 metre AFFL.

Engraved: PUSH TO EXIT (Green) for normal egress.

ONLY USE IN CONJUNCTION with a secondary independent emergency door release system. It is your responsibility to check and ensure your installation complies fully with Building Control regulations (www.labc.co.uk) for emergency safe egress.



EX-MHF Handsfree CONTACTLESS Exit Device

Q N° 008/3

HOW DOES A DOUBLE POLE (DP) EXIT BUTTON WORK?

NORMAL MODE

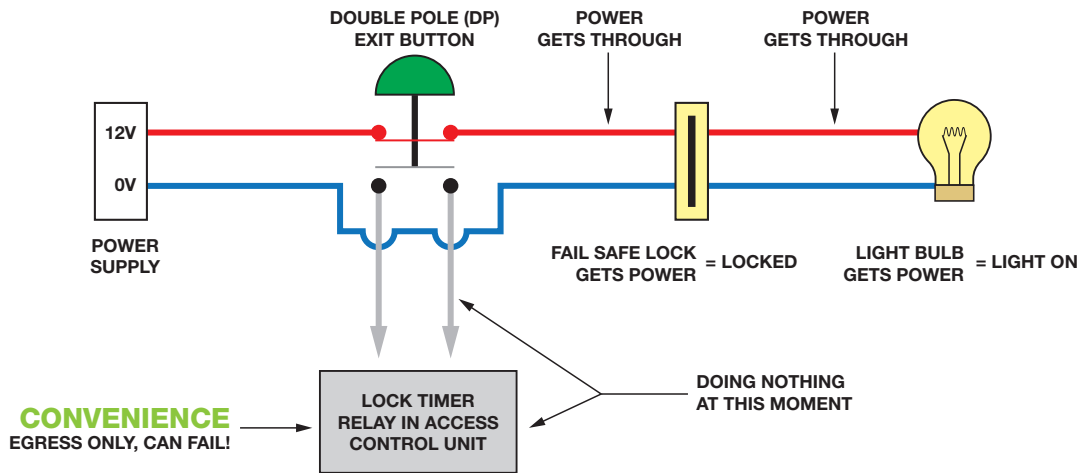

PRESS IN THE BUTTON TO EXIT

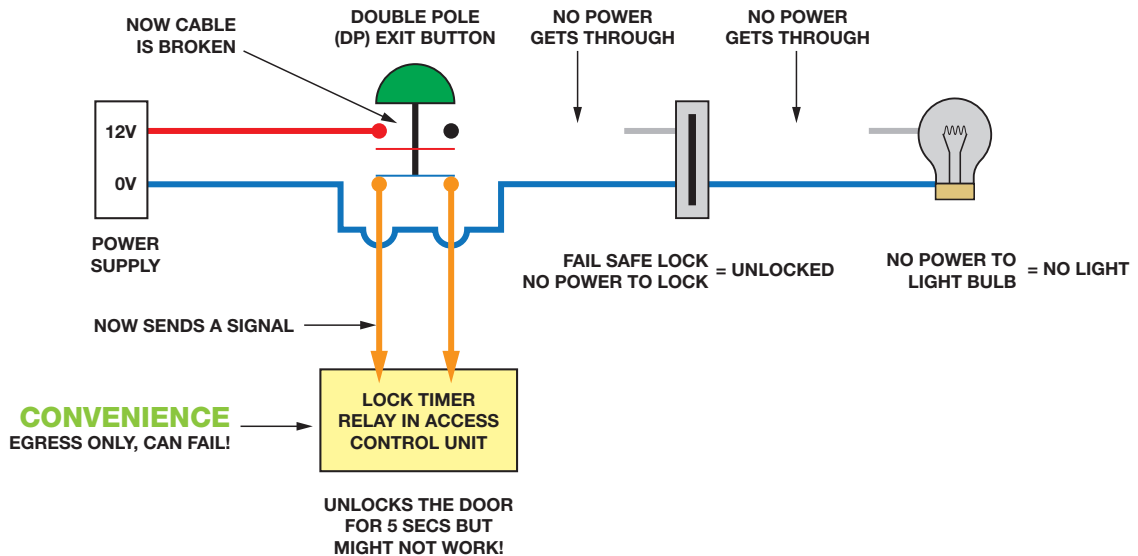

Are you sure the Exit button fitted is Double Pole?

Press the button in and check that the door stays unlocked and does not relock whilst you have your finger on the button.

EX-MHF Handsfree CONTACTLESS Exit Device

Q N° 008/4

**HEALTH & SAFETY! THINK SAFETY, THINK FIRE, THINK EMERGENCY EXIT.
PEOPLE'S LIVES DEPEND ON A CORRECT INSTALLATION.**

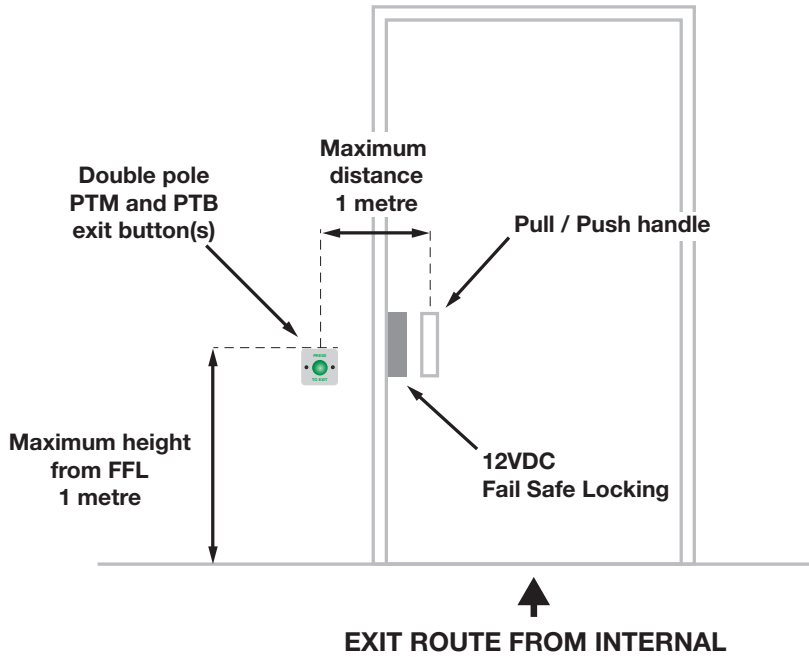

**HEALTH & SAFETY WARNING
NOT SAFE !**

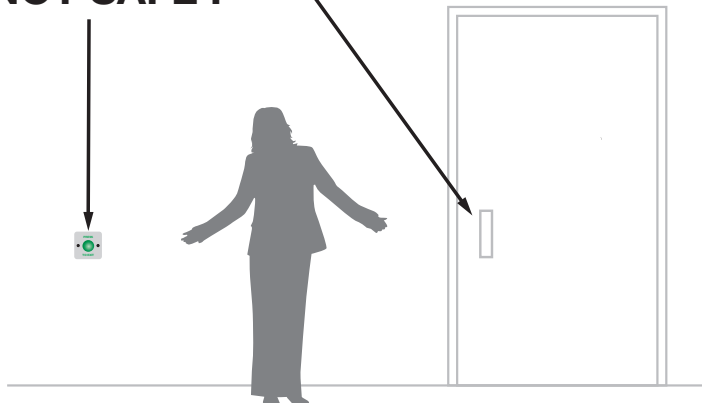

**If a person cannot reach the exit button
AND the door handle at the same time,
the safety PTB poles of the button are
USELESS. The installation is unsafe and dangerous.**

**REPORT
NON-COMPLIANT
INSTALLATIONS
IMMEDIATELY.**

**PEOPLE'S LIVES
DEPEND ON IT!**

ALL INSTALLATIONS MUST COMPLY WITH BUILDING CONTROL REGULATIONS



MAX 1 METRE DISTANCE AT MAX 1 METRE HEIGHT AFFL FROM DOOR PULL/PUSH HANDLE.

EX-MHF Handsfree CONTACTLESS Exit Device

Q N° 008/5

CORRECT POSITIONING OF EXIT BUTTON IS VITAL

The PTB (Push to Break) contacts on the button break the lock power circuit but only when the button is pressed in.

The instant the button is released, the lock is immediately re-powered and the door immediately locks.

If the person cannot both press the button in and push or pull the door open at the same time, the installation is dangerous.

1A CORRECT

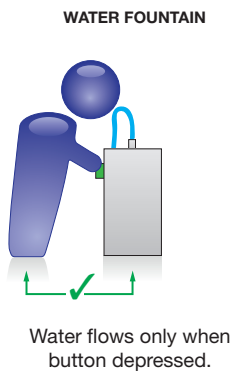

1B FAULTY & DANGEROUS!

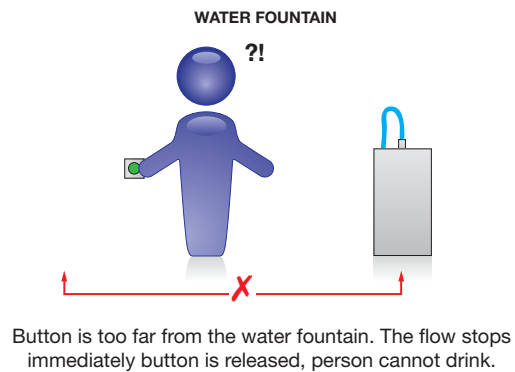

2A CORRECT

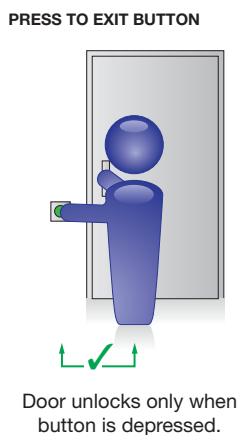

2B FAULTY & DANGEROUS!

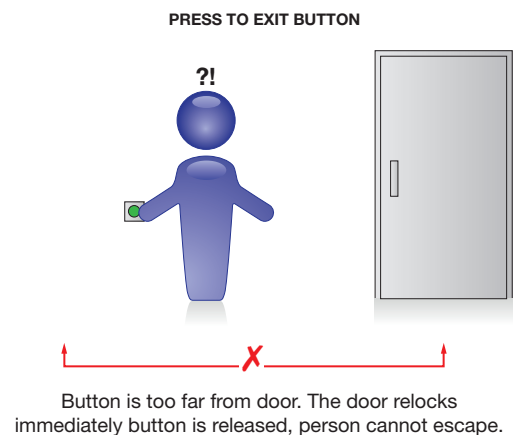

WARNING: Must be fitted within 1 metre maximum distance of the door exit pull/push handle at a maximum height of 1 metre from FFL.

Position carefully so that door does not open OVER the exit button(s).