



EM24EX-V3

To comply with both BS EN 60839-11-2 and the NSI NCP 109.3 Code of Practice for Illumination & Sound Indication.

Pressing the Emergency button momentarily:

Green light illuminates for the preset duration the electrical locking is released.



Alarm buzzer sounds for the preset duration the electrical locking is released.



SELF-RESETTING EMERGENCY EXIT SYSTEM

Designed to replace an EN54-11 type A manual call point in order to release fail safe electric release and fail safe electro-magnetic locking devices on access-controlled doors using indirect activation (BS 7273-4 category C) but substitutes a manual mechanical reset with a timed automatic reset. BS EN 13637: 2015 "Electrically controlled exit systems for use on escape routes" establishes that escape doors can be operated electronically.

Secured by Design



Official Police Security Initiative

SBD, New Homes 2014 (and ONWARDS)

"24.11 Break glass emergency door exit release... on communal external doors that give access into the building... not permitted due to constant abuse."

SECURITY RISK



EM24EX-V3 (FAIL SAFE TIMER RELAY) SELF-RESETTING EMERGENCY EXIT SYSTEM

For 12VDC fail-safe locking applications only.

PRESS & HOLD of the Emergency button also cuts power to the EM24EX (Fail Safe Timer Relay) so both its lock relays fail (they need power to be operational) thereby **mechanically (physically) breaking** the fail safe lock power circuits so electrical locking released.

AUTOMATICALLY SELF-RESETS



PRESSING THE EMERGENCY BUTTON MOMENTARILY (Press & Release) acts as a power OFF / ON to the EM24EX (Fail Safe Timer Relay) which activates the hold unlocked release feature of the electrical locking for the preset duration period.

To comply with both BS EN 60839-11-2 and the NSI NCP 109.3 Code of Practice for Illumination & Sound Indication.

Pressing the Emergency button momentarily:

Green light illuminates for the preset duration the electrical locking is released.



Alarm buzzer sounds for the preset duration the electrical locking is released.



PRESS & HOLD of the Emergency button also **mechanically (physically) breaks** the lock power circuit so electrical fail safe locking released.

EMERGENCY BUTTON

Building Regulations Part M (Access), Clause 2.17C.

"Doors must be openable.....using a CLOSED/CLENCHED fist..."

The Emergency button must be raised proud of the mounting surface to comply.



BS-EN-11 provides examples of symbols on emergency "call-points", to simplify understanding of usage for all.

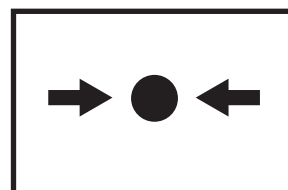
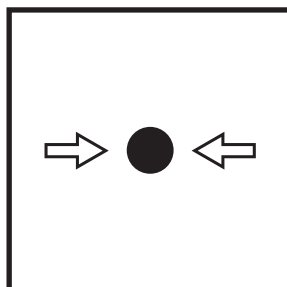

EM24EX-V3 (FAIL SAFE TIMER RELAY) SELF-RESETTING EMERGENCY EXIT SYSTEM

For 12VDC fail-safe locking applications only.

SECURED BY DESIGN, NEW HOMES 2014 (ONWARDS):

24.11 Break glass emergency door exit release devices (often green in colour) on communal external doors that give access into the building are **not permitted due to constant abuse**. Instead, **vandal resistant stainless steel** self-resetting emergency exit systems are to be installed. **The installation and system type must be in full compliance and achieve final 'sign-off' by local Building Control.**

SECURITY RISK DOES NOT AUTOMATICALLY RESET



PLASTIC SO EASILY
VANDALISED OR
ANTI-SOCIAL ACTIVATION
= DOOR REMAINS UNLOCKED !

SBD, New Homes 2014 (and ONWARDS)
"24.11 Break glass emergency door exit release... on communal external doors that give access into the building... not permitted due to constant abuse."

EM24EX-V3 AUTOMATICALLY SELF-RESETTING



MUST BE STAINLESS STEEL
VANDAL RESISTANT

To comply with both BS EN 60839-11-2 and the NSI NCP 109.3 Code of Practice for Illumination & Sound Indication.

Pressing the Emergency button momentarily:

Green light illuminates for the preset duration the electrical locking is released.

Alarm buzzer sounds for the preset duration the electrical locking is released.



Designed to replace an EN54-11 type A manual call point in order to release fail safe electric release and fail safe electro-magnetic locking devices on access-controlled doors using indirect activation (BS 7273-4 category C) but substitutes a manual mechanical reset with a timed automatic reset. BS EN 13637: 2015 "Electrically controlled exit systems for use on escape routes" establishes that escape doors can be operated electronically.

 MAX 1 METRE DISTANCE AT MAX 1 METRE HEIGHT AFFL FROM DOOR PULL/PUSH HANDLE.

EM24EX-V3 (FAIL SAFE TIMER RELAY) SELF-RESETTING EMERGENCY EXIT SYSTEM

For 12VDC fail-safe locking applications only.

IMPORTANT:

The specification (based on application and security level requirements) and the installation of Door Release and Emergency Exit devices on communal doors must be in full compliance with the relevant Building Regulations, achieve final 'sign-off' by local Building Control / Approved Inspector (as applicable), and must comply fully with any fire evacuation policies.

A detailed commissioning sheet is required for each door and it must be signed and clearly identify the installer. If you do not receive a satisfactory commissioning sign-off, do not accept the installation.

This is a safety device to guarantee escape in the event of an emergency.



EM24EX-V3 + 1F
FLUSH

Flange: 160 mmH x 145 mmW
Backbox: 130 mmH x 113 mmW x 50 mmD



EM24EX-V3 + 1S
SURFACE

120 mmH x 104 mmW x 50 mmD

ALL EXTERNALLY RATED

Designed to replace an EN54-11 type A manual call point in order to release fail safe electric release and fail safe electro-magnetic locking devices on access-controlled doors using indirect activation (BS 7273-4 category C) but substitutes a manual mechanical reset with a timed automatic reset. BS EN 13637: 2015 "Electrically controlled exit systems for use on escape routes" establishes that escape doors can be operated electronically.



**MAX 1 METRE DISTANCE AT MAX 1 METRE
HEIGHT AFFL FROM DOOR PULL/PUSH HANDLE.**

EM24EX-V3 (FAIL SAFE TIMER RELAY) SELF-RESETTING EMERGENCY EXIT SYSTEM

For 12VDC fail-safe locking applications.

SAFETY FEATURE nos 1 and 2.

When the bottom emergency exit button is pressed it also simultaneously removes power from the EM24EX-V3.

Power returns immediately the bottom button is released.

This split second power off then back on triggers the EM24EX-V3 "hold-open" operation which breaks both lock power circuits for a preset period of 3 minutes which means that the door is unlocked for 3 minutes.

Pressing the bottom emergency button removes power from the EM24EX-V3. So whilst the bottom button is held pressed in no power gets to the EM24EX-V3 fail safe powered relay so both its lock relays fail (they need power to be operational) thus breaking the locking power circuits so no power gets to the fail safe lock. The door is unlocked.

The 3 minute "hold open" AUTO-RESETTING latching function of the EM24EX-V3 is an additional feature that becomes irrelevant should the EM24EX-V3 (for any reason) malfunction = fail safe lock fails = the door is unlocked permanently, not just for 3 minutes, engineer call-out required to fix so that the door can be relocked.

SAFETY FEATURE no 3.

When the bottom emergency exit button is pressed it also mechanically breaks the lock power circuit. No power gets to the fail safe lock whilst the button is held pressed in = Door is unlocked.

SAFETY FEATURE nos 4 and 5.

If the Power Supply Unit (PSU) servicing the EM24EX-V3 fails, no power gets to the EM24EX-V3 fail safe powered relay so both its lock relays fail (they need power to be operational) thus breaking the locking power circuits so no power gets to the fail safe lock. The door is unlocked.

SAFETY FEATURE nos 6 & 7.

If the Power Supply Unit (PSU) servicing the fail safe lock fails, no power gets to the lock. The door is unlocked.

SAFETY FEATURE nos 8 & 9.

If the EM24EX-V3 Fail Safe 12VDC Powered Timer Relay fails for any reason both lock relays fail breaking the locking power circuits so no power gets to the fail safe lock. The door is unlocked.

IMPORTANT

If any cable core from either of the Exit Buttons to the EM24EX-V3 relay, or from the Power Supply to the EM24EX-V3 relay, or on the EM24EX-V3 relay itself breaks or detaches – the electric fail safe lock will immediately fail = The door is unlocked.

The EM24EX-V3 relay does not need control resets but as with all life safety products it is a requirement to include it in the maintenance schedule.



MAX 1 METRE DISTANCE AT MAX 1 METRE HEIGHT AFFL FROM DOOR PULL/PUSH HANDLE.

From: Louis Taylor [mailto:LoTaylor@nhbc.co.uk]
Sent: 30 June 2014 16:51
To: Richard Collis
Subject: RE: urgent question , need guidanceCycle stores locking.

Dear Richard,

Double pole (DP) Exit Button only is NOT permitted

Doors that require you to hold down a button whilst pushing a door would not be permitted as it's a requirement of both Part B (Fire Safety) and Part M (access – for the disabled) that the door is openable without having to manipulate more than one mechanism, using a clenched fist. This is so that persons with limitations with their hands/limbs only have to use one limb to open. If you thus need two hands to operate such devices they would not be permitted and should not thus be used.

If you've any other queries regarding the above please feel free to get in touch.

Kind regards

Louis

The Exit Button needs to be of sufficient diameter, or suitable shape to be depressed and released using a clenched fist.

Louis Taylor MRICS BEng(Hons) MSc MCABE C.Build E

Commercial Building Control Surveyor

Direct line: 0114 2864289

email: lotaylor@nhbc.co.uk

NHBC | NHBC House | Davy Avenue | Knowlhill | Milton Keynes | MK5 8FP

Tel: 0844 633 1000 | Fax 0844 633 0022 | www.nhbc.co.uk



EMERGENCY BUTTON

Building Regulations Part M (Access), Clause 2.17C.

“Doors must be openable... using a CLOSED/CLENCHED fist...”

The Emergency button must be raised proud of the mounting surface to comply.



VISITOR PANELS, PROXIMITY READERS, KEYPADS, EXIT BUTTONS, EMERGENCY EXIT DEVICES MUST BE EQUALITY ACT 2010 (DDA) COMPLIANT

THE DISABILITIES THAT MUST BE ADDRESSED ARE:



Hearing problems



Visual problems



Wheelchair users



Elderly, mobility problems



Arthritic

Equality Act 2010 compliance

Equality Act 2010 compliance means that the service provided must not discriminate against people with disabilities. The objective of the ACT is to make sure that disabled persons can access the services that have been provided as easily as able bodied persons.

It is, therefore, **reasonable** that a visitor door entry system must not be audio only – if it is to comply with the **Equality Act** because **a resident with a hearing disability** would clearly be disadvantaged and **would benefit from being able to view visual images.**

Visuals from a visitor door entry system must be provided to flats.

A resident with a visual, hearing or mobility disability needs to be able to view, hear, speak and open the door to the visitor as easily as an able bodied person.

It is **reasonable** to expect that the visitor door entry panel, resident access control proximity readers / keypads, exit buttons, emergency exit devices are designed with **reasonable features** to make actual usage as easy as possible for persons with disabilities. For example; buttons should be large, tactile, braille embossed, raised, illuminated as applicable. There should be bright colour display screens, voice and visual information output messages, visual icons, audible alarms and hearing aid loops.

Fireman switches, trades buttons, programming buttons and cameras are not used by visitors and so have marginal relevance to Equality Act 2010 compliance; for example, the camera providing the visual pictures (services) to residents is not a 'touch' device used by visitors.

The Equality Act 2010, the "ACT", requires public bodies, landlords and other service providers to prevent and address disability discrimination. The Equality Act serves not only to ensure that these various bodies do not discriminate, but there can also be a positive legal requirement on these bodies to make **reasonable changes** to improve services for disabled people.

The Equality Act protects anyone with a **disability**, defined as "a physical or mental impairment that has a substantial and long-term adverse effect on the ability to carry out normal day-to-day activities". Blind, visually impaired, hearing impaired, speech impaired, arthritic and the mobility impaired (physically disabled and elderly) are all protected as **disabled**.

The requirement to make **reasonable changes** applies to landlords and service providers. A service provider is defined in the Equality Act as "a person concerned with the provision of a service to the public or a section of the public (for payment or not)". This is clearly a wide definition and includes all bodies that deal directly with members of the public, including Housing Associations and all other services provided by government departments. A builder would be a service provider to the extent that they provide services to the public. This duty requires service providers to take positive steps, and not simply to avoid discrimination. **Reasonable changes are required wherever disabled people would be at a substantial disadvantage compared with non-disabled people. A substantial disadvantage is defined as a "disadvantage which is more than minor or trivial".**

Importantly, landlords and service providers are now obliged to think ahead and take steps to address barriers that impede disabled people and not wait until a disabled person experiences difficulties using a service.

Furthermore, the Equality Act also imposes a duty on public bodies (under section 149) to "advance equality of opportunity between persons who share a relevant protected characteristic and persons who do not share it". The definition of public body includes councils, hospitals, police across the UK. Therefore, failure by a public body to approve of systems that can assist persons with disabilities may be in breach of disability discrimination legislation, and failure by a public body to use systems that can assist persons with disabilities may be in breach of disability discrimination legislation.

The following may be considered as examples of **disability discrimination:**

1. Failure by a public body, landlord or other service provider to approve or implement visitor door entry systems and/or resident access control systems which would assist disabled persons.
2. Approval (or failure to adjust) by a public body, landlord or other service provider of a visitor door entry system and/or resident access control system which places disabled people at a disadvantage which is more than minor or trivial.

THE DISABILITIES THAT MUST BE ADDRESSED ARE:



Hearing problems



Visual problems



Wheelchair users



Elderly, mobility problems



Arthritic

Always think LIFE SAFETY!

What if it was my child or elderly parent needing to escape in an emergency?

And what about these people?

Have **reasonable** features been provided to make it easy for them to use the Egress, Access and Visitor Entry?

A person with:

severe arthritis
cerebral palsy
one hand, one arm or one leg
a broken arm or leg in plaster
coordination problems
no hands

A person:

who has collapsed because of the smoke
who is panicked
using a walking stick for balance
in a wheelchair
visually impaired
hearing impaired

A mother carrying a baby

An elderly frail person

A child

“the operation of switches... does not require the simultaneous use of both hands”



It is **NOT permitted** to have a system where the only emergency exiting procedure requires that the person **needs to hold in a button and at the same time pull/push the door** because many people will not be capable of doing this.

The Emergency Exit Button must have a latching UNLOCK facility so that when pressed momentarily which means - in the normal way so pressed and immediately released - the electric locking system on **the door latches unlocked for a minimum period of 3 minutes**. This means that (1) the person escaping does not need to operate two things at once (2) **a person who has collapsed due to smoke and crawled up to the door is not faced with a locked door.**

Must be fitted within 1 metre maximum distance of the door exit pull/push handle at a maximum height of 1 metre AFFL.

“Doors must be openable without having to manipulate more than one mechanism, using a **CLOSED/CLENCHED fist...**”



Wheelchair users



Elderly, mobility problems



Arthritic

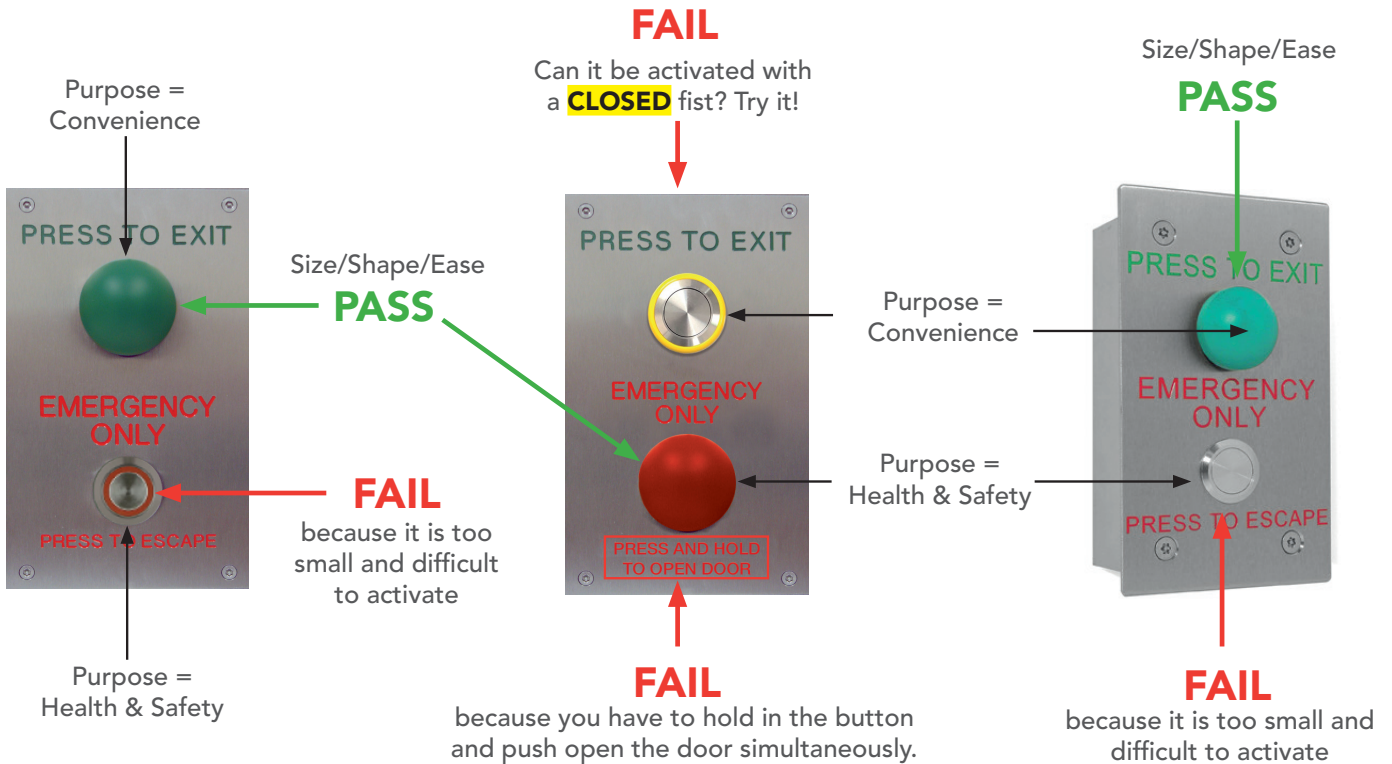

EMERGENCY BUTTON



Building Regulations Part M (Access), Clause 2.17C.

“Doors must be openable.....using a **CLOSED/CLENCHED fist...**”

The Emergency button must be raised proud of the mounting surface to comply.

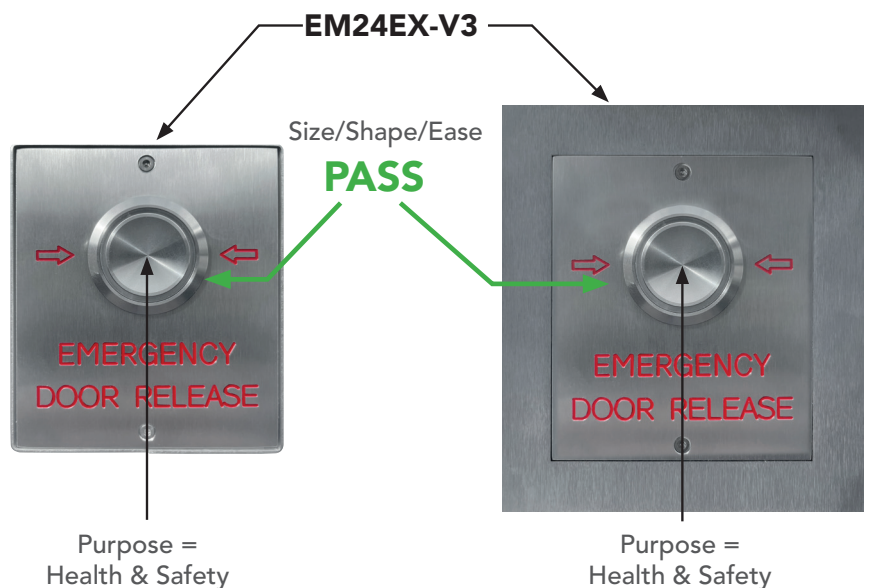

IMPORTANT SAFETY WARNING

The mechanical Push to Break (PTB) safety features on the exit button(s) **ONLY WORK** if the door can be pulled / pushed open whilst holding the button pressed in.

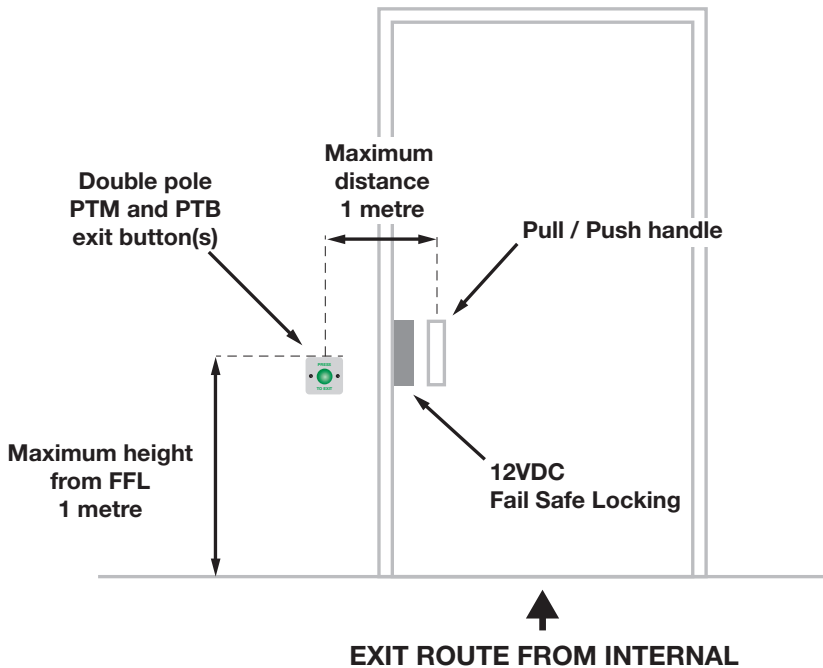

**THINK SAFETY,
THINK FIRE, THINK
EMERGENCY EXIT.
LIVES DEPEND
ON A CORRECT
INSTALLATION.**

**REPORT
NON-COMPLIANT
INSTALLATIONS
IMMEDIATELY.
LIVES DEPEND
ON IT!**

HEALTH & SAFETY WARNING

NOT SAFE !

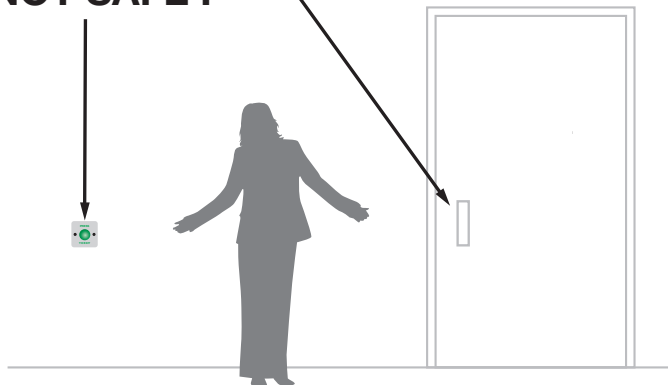

If a person cannot reach the exit button AND the door handle at the same time, the safety PTB poles of the button are USELESS. The installation is unsafe and dangerous.

ALWAYS CHECK THAT WHEN A BUTTON IS PUSHED AND HELD DOWN THE DOOR STAYS UNLOCKED AND DOES NOT RE-LOCK.

ALL INSTALLATIONS MUST COMPLY WITH BUILDING CONTROL REGULATIONS.

 **MAX 1 METRE DISTANCE AT MAX 1 METRE HEIGHT AFFL FROM DOOR PULL/PUSH HANDLE.**

CORRECT POSITIONING OF EXIT BUTTON(S) IS VITAL

The PTB (Push to Break) contacts on the button **mechanically** break the 12VDC Fail Safe lock power circuit but only when the button is pressed in.

The instant the button is released, the 12VDC Fail Safe lock is immediately re-powered and the door immediately locks.

If the person cannot both press the button in and push or pull the door open at the same time, the installation is dangerous.

1A CORRECT

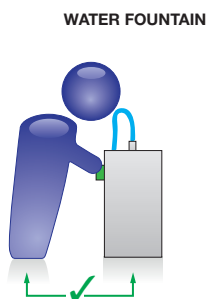

Water flows only when button depressed.

1B FAULTY & DANGEROUS!

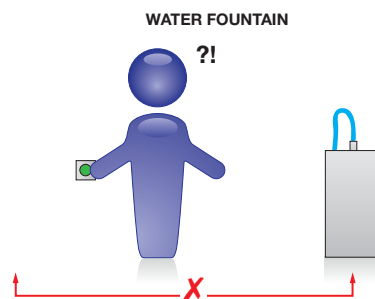

Button is too far from the water fountain. The flow stops immediately button is released, person cannot drink.

2A CORRECT

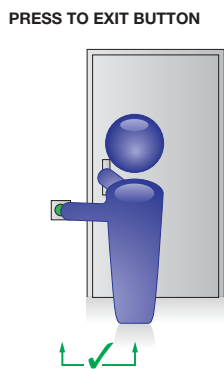

Door unlocks only when button is depressed.

2B FAULTY & DANGEROUS!

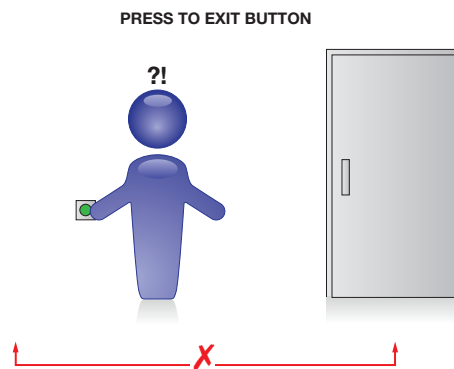

Button is too far from door. The door relocks immediately button is released, person cannot escape.

WARNING: Must be fitted within 1 metre maximum distance of the door exit pull/push handle at a maximum height of 1 metre from FFL.

Position carefully so that door does not open OVER the exit button(s).

EM24EX-V3 SELF-RESETTING EMERGENCY EXIT SYSTEM CABLING CONFIGURATION

EM24EX-V3 (12VDC POWERED RELAY)

**EM24EX-V3 IS A
FAIL SAFE
DEVICE FOR
SAFETY REASONS.**

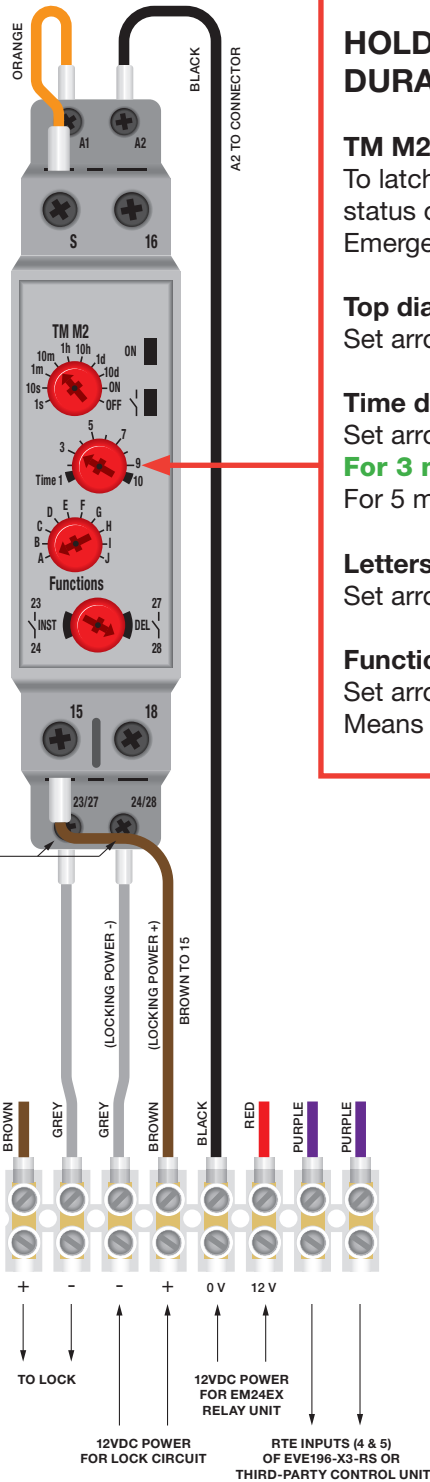

HOLD-UNLOCKED TIME DURATION SETTINGS

TM M2 (top) dial
To latch open (hold unlocked) electric locking (change status of locking from locked to unlocked) when Emergency Button is momentarily pressed and released.

Top dial
Set arrow to always point to 10M

Time dial
Set arrow to point as follows to hold unlocked
For 3 mins = 3 Do not go lower than 3 mins
For 5 mins = 5

Letters dial
Set arrow to always point to A

Function dial
Set arrow to always point to 28
Means relays 15-18 & 23/27-24/28 mimic each other.

EM24EX-V3 SELF-RESETTING EMERGENCY EXIT SYSTEM CABLING CONFIGURATION

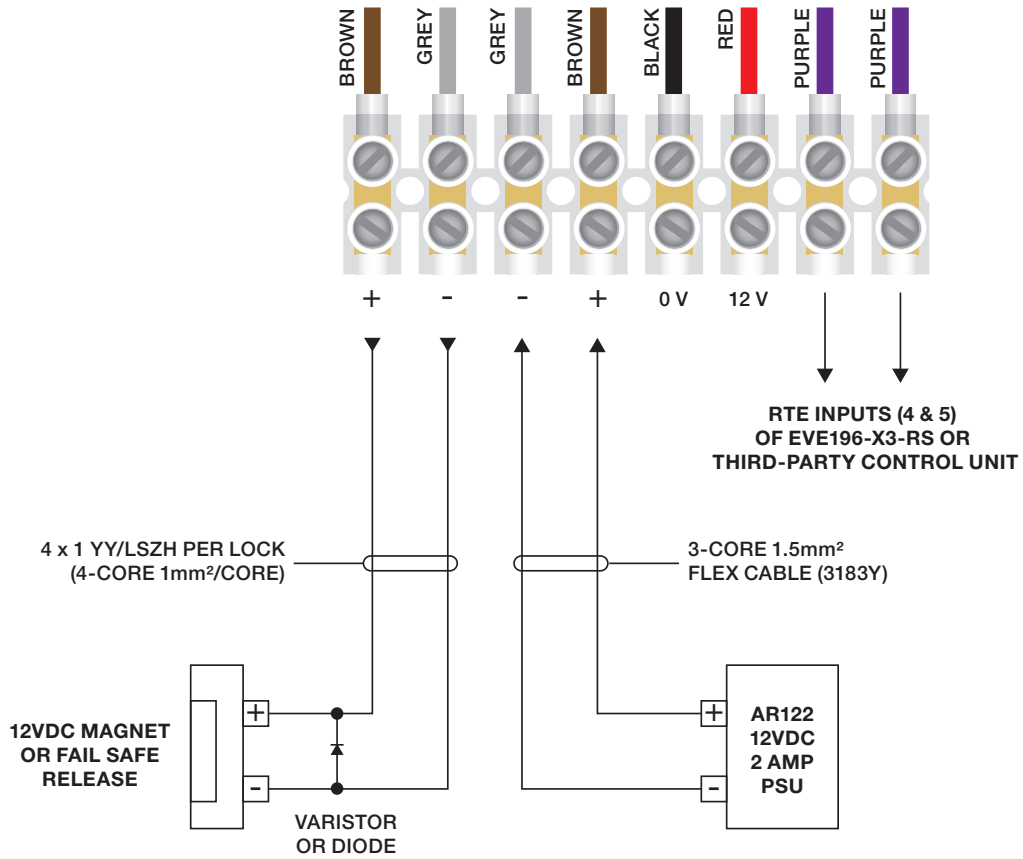

EM24EX-V3 STAINLESS STEEL HOUSING

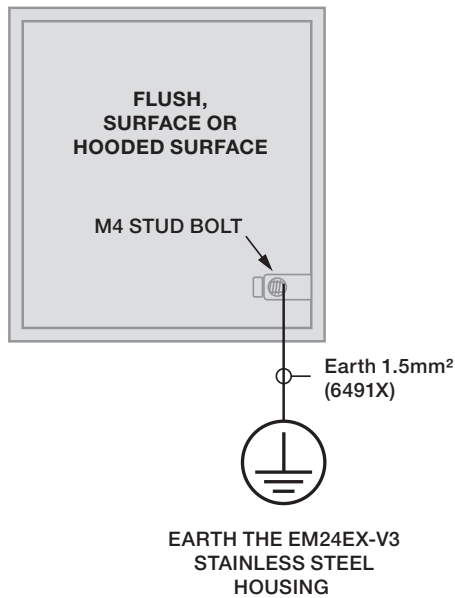

EM24EX SELF-RESETTING EMERGENCY EXIT SYSTEM

EM24EX CABLING SPECIFICATIONS

T N° 070/4 with SBD compliant EM24EX system

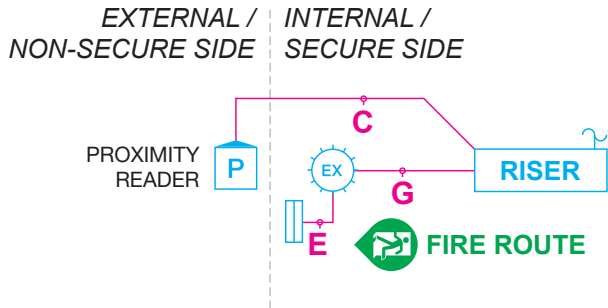

T N° 070/2 with SBD compliant EM24EX system

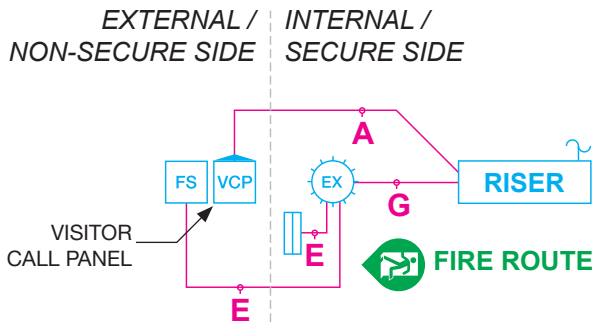

INSTALLATION COMPONENTS

	12VDC fail safe electric release or electro-magnet (as per advice or pre-installed by door supplier for door type, designation and usage profile).	L08
	Fireman switch.	L16
	EM24EX stainless steel normal exit + self-resetting emergency exit system (fitted within 1 metre maximum distance of the relevant door exit pull/push handle at a maximum height of 1 metre from FFL). All locking must be 12VDC fail safe.	L41
	EM24EX-VR stainless steel self-resetting emergency exit system (fitted within 1 metre maximum distance of the relevant door exit pull/push handle at a maximum height of 1 metre from FFL). All locking must be 12VDC fail safe.	L41A

CABLING

- A** Class E (CAT6) U/UTP x 4no + Earth 1.5mm² (6491X)
- C** Class E (CAT6) U/UTP + Earth 1.5mm² (6491X)
- E** Lock circuit cable ref. 4 x 1 YY/LSZH per lock (4-core, 1mm²/core)
- G** Lock circuit cable ref. 4 x 1 YY/LSZH per lock (4-core, 1mm²/core) + Class E (CAT6) U/UTP x 1no

LOCKING CIRCUIT CABLE 4 x 1 YY/LSZH (3184B LSZH)

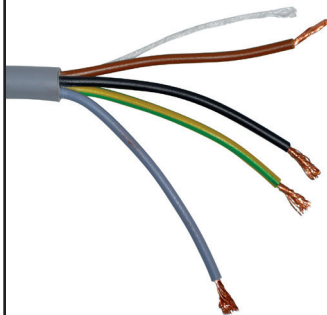

Maximum distance from locking to power supply location:
 50 metres for 1 amp lock
 30 metres for 2 amp lock

CABLE REFERENCE:
 4 x 1 YY/LSZH
PER LOCK

Fail safe locking relies on the locking receiving the correct voltage and current. Only industry reference 4 x 1 YY/LSZH cabling (or Fire Protected equivalent, if applicable) is to be used. Alarm, data or communications cabling; for example; CAT5E, CW1308 is unacceptable.

Conductors:	Flexible copper, class 5.
Core identification:	4 core: brown, grey, black, green/yellow
Insulation:	LSZH
Sheath/Jacket:	LSZH
Colour:	Grey
Voltage:	300/500V
Operating temperature:	-5°C / + 70°C
Minimum bending radius:	6 x overall diameter
Standards:	BS EN 50525-3-11, EN 61034-2, EN 60332-1-2.

Core size sq.mm	No of cores	Radial thickness of insulation mm	Nominal overall diameter mm	Weight kg/km
1	4	0.6	7.9	99

T: 01322-441165 Product ref: 3184B-Grey Part number: 45574 www.batt.co.uk



+44 (0)1442 211848
estimating@nacd.co.uk

www.nacd.co.uk
f in nacdltd

Unit 8, Heron Business Park, Eastman Way,
Hemel Hempstead, Hertfordshire, HP2 7FW

